



The installation may only be carried out by a technician
Nur ein Techniker kann die Installation durchführen
Instalaci smí provádět pouze technik
Inštaláciu môže vykonať iba technik

This product contains a light source of energy efficiency class G
Dieses Produkt enthält ein Leuchtmittel der Energieeffizienzklasse G
Tento výrobek obsahuje světelný zdroj třídy energetické účinnosti G
Tento výrobok obsahuje svetelný zdroj triedy energetickej účinnosti G



(EN) CAUTION!

Turn off the main power before proceeding with the installation in order to prevent possible shock. The installation may only be carried out by a technician or a qualified person. If the lamp has a lampshade/diffuser, handle it carefully as it is fragile. With an integrated LED light source, only a technician or a qualified person can make the replacement. The manufacturer is not responsible for the incorrect use and assembly of its products.

(DE) ACHTUNG!

Vor der Installation ist es notwendig, den Hauptstromkreis zu unterbrechen, um ein Stromschlag zu vermeiden. Die Installation darf nur von einem Techniker oder einer qualifizierten Person durchgeführt werden. Wenn die Lampe einen Lampenschirm/Diffuser hat, gehen Sie vorsichtig damit um, da sie zerbrechlich ist. Mit einer integrierten LED-Lichtquelle kann nur ein Techniker oder eine qualifizierte Person den Austausch vornehmen. Der Hersteller ist nicht verantwortlich für die fehlerhafte Verwendung und Montage seiner Produkte.

(SK) UPOZORNENIE!

Pred inštaláciou je nevyhnutné odpojiť hlavný elektrický okruh, aby ste predišli zasiahnutiu elektrickým prúdom. Montáž môže vykonať iba kvalifikovaná osoba. V prípade, že má svietidlo tienidlo/difúzor, narábajte s ním opatrne, pretože je krehké. Pri integrovanom LED svetelnom zdroji môže výmenu zrealizovať iba technik alebo kvalifikovaná osoba. Výrobca nenesie zodpovednosť za nesprávne zachádzanie s produktom.

(CZ) UPOZORNĚNÍ!

Před instalací je nutné odpojit hlavní elektrický okruh, abyste předešli zasažení elektrickým proudem. Montáž může provádět pouze kvalifikovaná osoba. V případě, že má svítidlo stínidlo/difuzor, zacházejte s ním opatrně, protože je křehké. Při integrovaném LED světelném zdroji může výměnu zrealizovat pouze technik nebo kvalifikovaná osoba. Výrobce nenesie odpovědnost za nesprávné zacházení s výrobkem.



1 Security related information

- Installation should be carried out in accordance with the latest edition of the I.E.E. Wiring regulations and taking into consideration the latest building regulations.
- Ensure that all electrical connections are tight with no loose strands, including factory made connections.
- Ensure there is adequate free air circulation of at least 100mm around the luminaire. It is the installer's responsibility to consider fire risk and take appropriate precautions.
- A separate enclosure may be required if this unit is to be used in dusty and wet environments.

Q.C. date label, installation in an improper working environment or installation not according to the current edition of the I.E.E. Wiring Regulations. The guarantee is also invalidated if the luminaire has been I.R. tested. Should this product fail during the guarantee period it will be replaced free of charge, subject to correct installation and return of the faulty unit. We do not accept responsibility for any installation costs associated with the replacement of this product. Your statutory rights are not affected. We reserve the right to alter specifications without prior notice.

2 Packing list



1m hanging pack

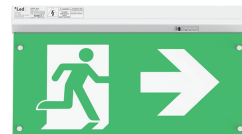

The Sign*1
Arrow Left/right pre-installed



Spare pictogram
Arrow Up/Down, EXIT

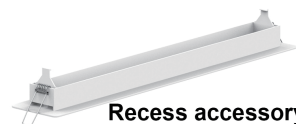

Recess accessory *1
Optional



Installation pack



Usermanual

3 Basic Parameters

Model	SAFE ALL
	ST
Material	Polycarbonate + PMMA
LED Chips	20pcs SMD 4014
Degree of protection	IP40
Input Voltage	AC200-240V 50/60HZ
Input power	2W
Power factor	>0.5
Emergency changeover	<0.5S
Emergency mode	Maintained & non-maintained
LED lifespan	50,000 hrs
Guarantee	5 years (Battery 4 years)
Emergency Standard	60598 - 2-22:2021
Legend standard	ISO7010:2019
The Photonetic	ISO 3864 - 4:2011 / EN 1838 - 2013
Emergency Pack	3.6V 0.6Ah
Emergency time	3 Hours
Test	Manual test + self-test
Mains indicator (M)	Green
Charging indicator (C)	Green
Faulty indicator (F)	RED
Charging details	100mA, Full charged in 12 hours
Discharging details	250mA, 3 hours emergency time
Luminous Flux(Mains)	50LM
Luminous Flux(EM)	50LM

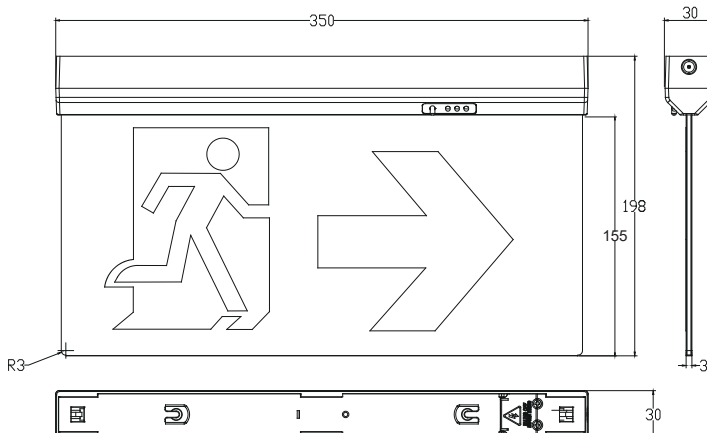

4 General construction

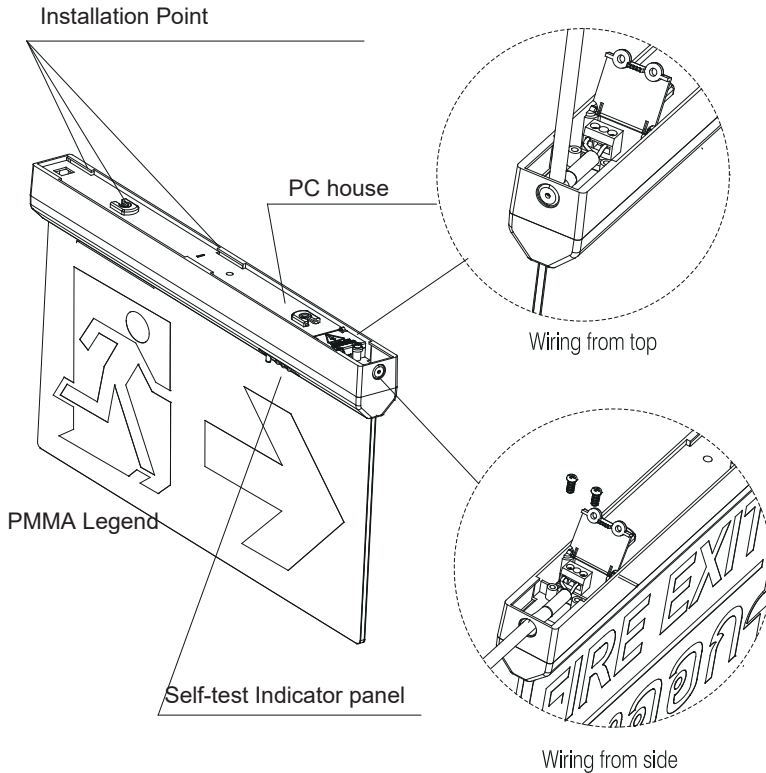

4# . Rest mode & storage

4#.1 This luminaire combined rest mode.

When the AC supply failure / cut down. The EM LED on.

- If the battery over discharged, The luminaire will changeover rest mode automatically.
- You can click the **④ test button**. and the luminaire also can changeover rest mode.

4#.2 Storage & transportation

- Make sure the luminaire in rest mode
- Keep the storage temperature 0~30°C
- Keep away from inflammables; keep dry & ventilation.

5 Self test system

5.1 Testing (If no failure)

5.1.1. Manual function test.

Active the ④ test button.

- a) The ② Charging indicator OFF.
- b) The Emergency function ON.
- c) The test will cut off the mains

5.1.2 Monthly test.

Active the ④ test button for 5 second;
or the lamp installed every 30 days.

- a) The ② Charging indicator will flash in 1Hz for 128s;
- b) The Emergency function ON;
- c) The test finished and back to standby mode.



5.1.3 Annual test.

Active the ④ test button for 7 second;
or the lamp installed every 180 days.

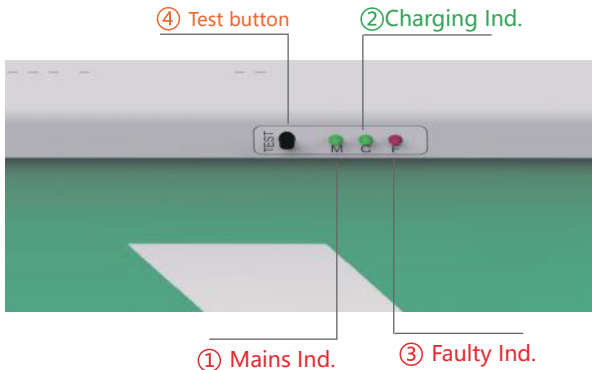
- a) The ② Charging indicator will flash in 2Hz for 3 hours;
- b) The charging will be cut off & emergency function ON 3 hours;
- c) The lamp back to standby mode after test.















5.2 Testing (If any failure, SAFE ALL - ST)

- 5.2.1 Battery failure:  Monitored constantly. The ③ faulty indicator will flash in 1 Hz if the battery failure any time.
- 5.2.2 LED load failure:  If press test button, or the luminary self-monthly test. The ③ faulty indicator will flash in 2 Hz if LED load failure.
- 5.2.3 Duration failure:  Only in Annual self-test. The ③ faulty indicator will turn on constantly if the Battery can not last 3 hours

6 Emergency control logic

The emergency function control logic

Operation	Mains indicator (Green)		Charging indicator (Green)		Faulty Indicator (RED)		Emergency LED Maintained mode		
	1 Second	1 Second	1 Second	1 Second	1 Second	1 Second	1 Second	1 Second	
Normal charging	Constantly on		Constantly on		OFF		Constantly on		
Normal AC Failure	OFF		OFF		OFF		Constantly on		
Manual test	OFF		OFF		OFF		Constantly on		
Monthly self-test	OFF				OFF		Constantly on		
Annual self-test	OFF						Constantly on		
Battery circuit failure	Constantly on		OFF				Constantly on		
Light source failure	Constantly on		Constantly on						OFF
Duration test failure	Constantly on		Constantly on		Constantly on		Constantly on		

7 Emergency function & Wiring

ADDITIONAL INFORMATION - COMPONENT REPLACEMENT

- The luminaire contains no user replaceable components other than the battery pack contained in emergency versions.
- The battery has a 4 year service life provided it is operated and maintained by regular testing, as detailed in this Usermanual. Failure to maintain or change the battery may result in reduced duration in emergency mode.

7.1 Emergency function test before installation

- 7.1.1. Chose the cable wiring way according page 4.
Connect the AC cable according to the Dia 1.

- The Mains indicator on,
- The charging indicator on,
- The Faulty indicator off,

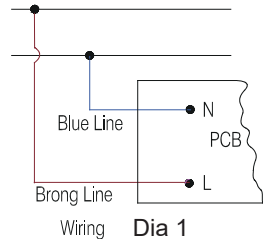

- 7.1.2. Press the test button, The charging indicator off, and emergency function activated.

- 7.1.3. Cut off the AC power supply, The mains indicator & Charging indicator off and emergency function on.

7.2 Maintained & non-maintained mode changeover

- a) The SAFE ALL was preset Maintained mode.

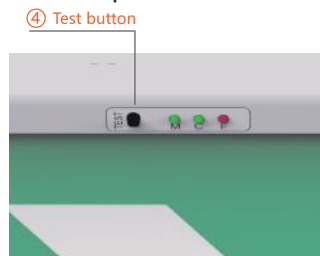

Press the ④ test button constantly for 11 seconds

- b) AC power on

Press the ④ test button constantly for 11 seconds

The SAFE ALL will change the Emergency work mode.

8 Installation guide



Caution

1. All Led2 emergency lights are designed for projects. Only qualified electrician can install or maintain it.
2. The mains have to be off during the installation or maintenance.
3. Keep the product far from heat sources and in a well ventilated area.



Installation pack

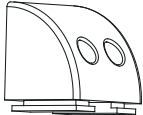

The Wall mounting Accessory

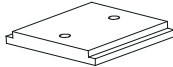

Ceiling mounting Accessory



Hanging mounting Accessory *2



Alligator Anchor*2



4*30 Screws * 2

Install the PVC Legend

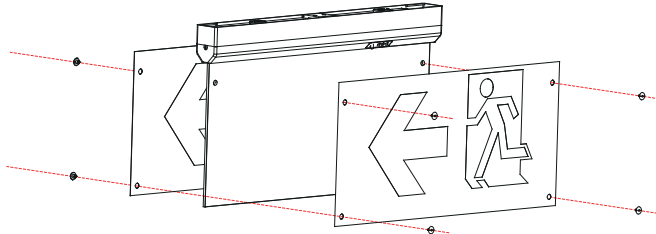
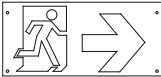
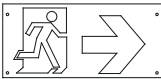

- 1) Chose the right PVC legend.
- 2) Install the legend by clips.

Installation 1: Ceiling mounting

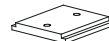
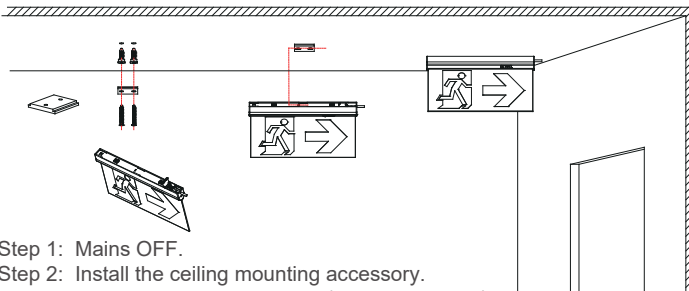

Ceiling installation device

Step 1: Mains OFF.

Step 2: Install the ceiling mounting accessory.

Add the auxiliary accessory (see right picture)

If the ceiling is not flat.

Step 3: Wiring The cable from side hole recommend and testing accoring Page 7

Step 4: Fix the sign on the ceiling

Step 5: Mains ON

Installation 2: Side wall mounting

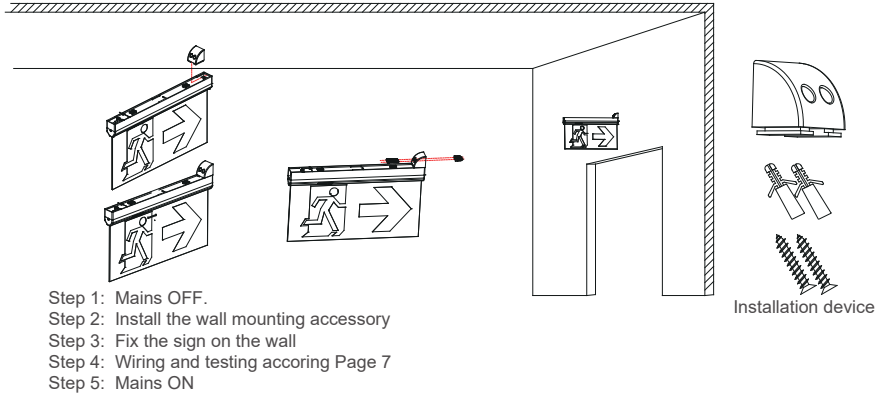

Installation 3: Wall mounting

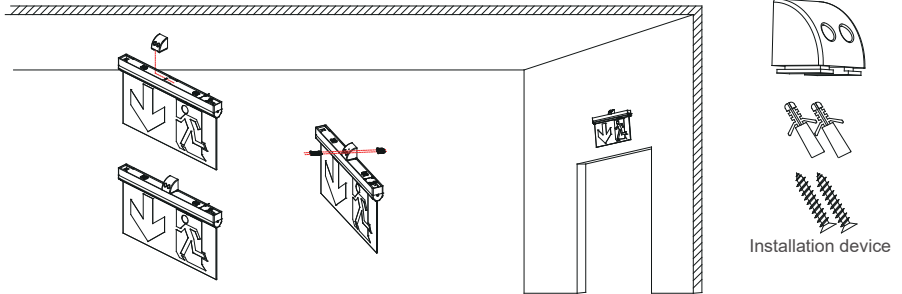

Installation 4: Recessed mounting

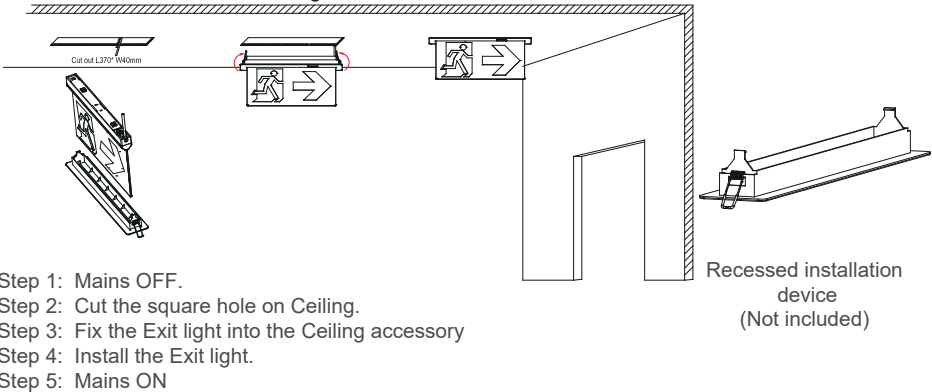

Installation 5: Hanging

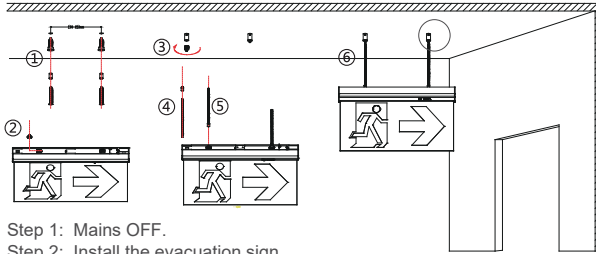

Step 1: Mains OFF.

Step 2: Install the evacuation sign

- ① Install the a) by screws, distance 180-200mm recommend.
- ② Install e) into the base of sign.
- ③ Install b) into a) by screwing.
- ④ Incer the c) string into d) from no stopper side.
- ⑤ Install c)+d) on to e) according the drawing by screwing.
- ⑥ Incer the string into b) set the length accroding Pic8.1.

Step 3: Wiring and testing accoring Page 7

Step 4: Mains ON



Pic8.1

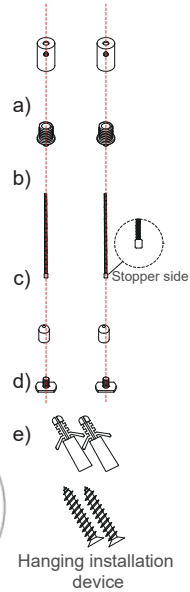

Installation 6: Hanging with canopy

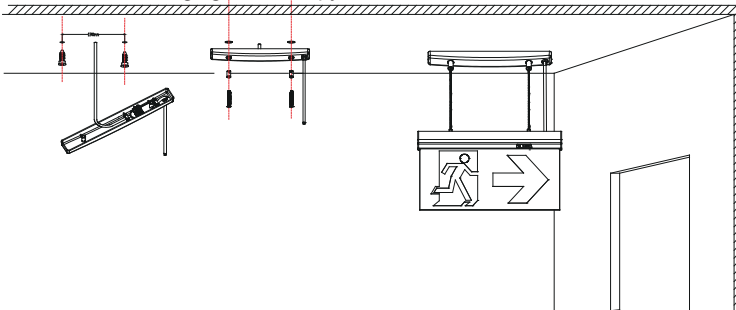

Step 1: Mains OFF.

Step 2: Connect the power cable to canopy.

Step 3: Fix the canopy together with a) of hanging accessory to the ceiling by 4*45mm screws

Step 4: Install the SAFETY ALL same as Installation 5

Step 5: Wiring and test accoring page 7

Step 6: Mains ON

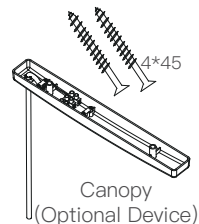
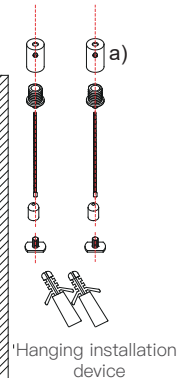

Canopy (Optional Device)

9 EM inspection record table

Luminaire emergency inspection record

month	Test	First Year		Second Year		Third Year		Fourth Year		Fifth Year	
		Signed	Date	Signed	Date	Signed	Date	Signed	Date	Signed	Date
1	Functional										
2	Functional										
3	Functional										
4	Functional										
5	Functional										
6	1 hour										
7	Functional										
8	Functional										
9	Functional										
10	Functional										
11	Functional										
12	3 hours										

Installed By: Installed Date: Luminaire NO.:

Luminaire Location: Contact details: